

753-436

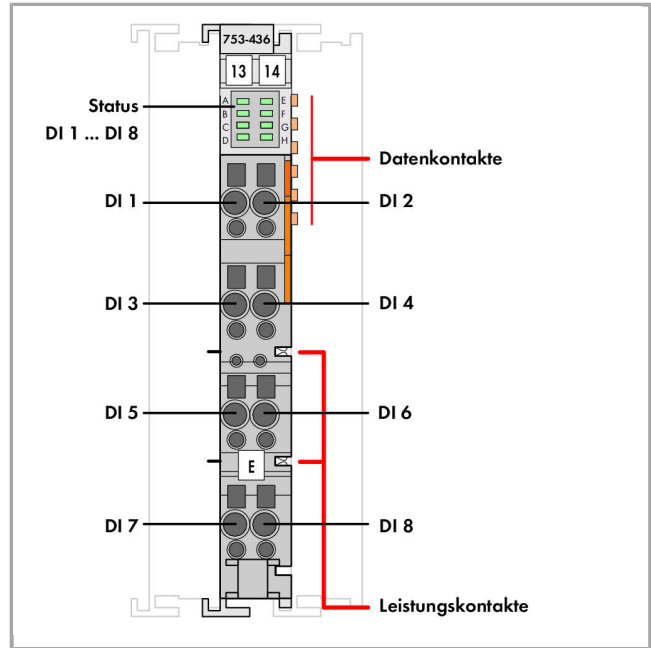

RoHS Compliant

[BOMcheck.net](https://www.bomcheck.net)

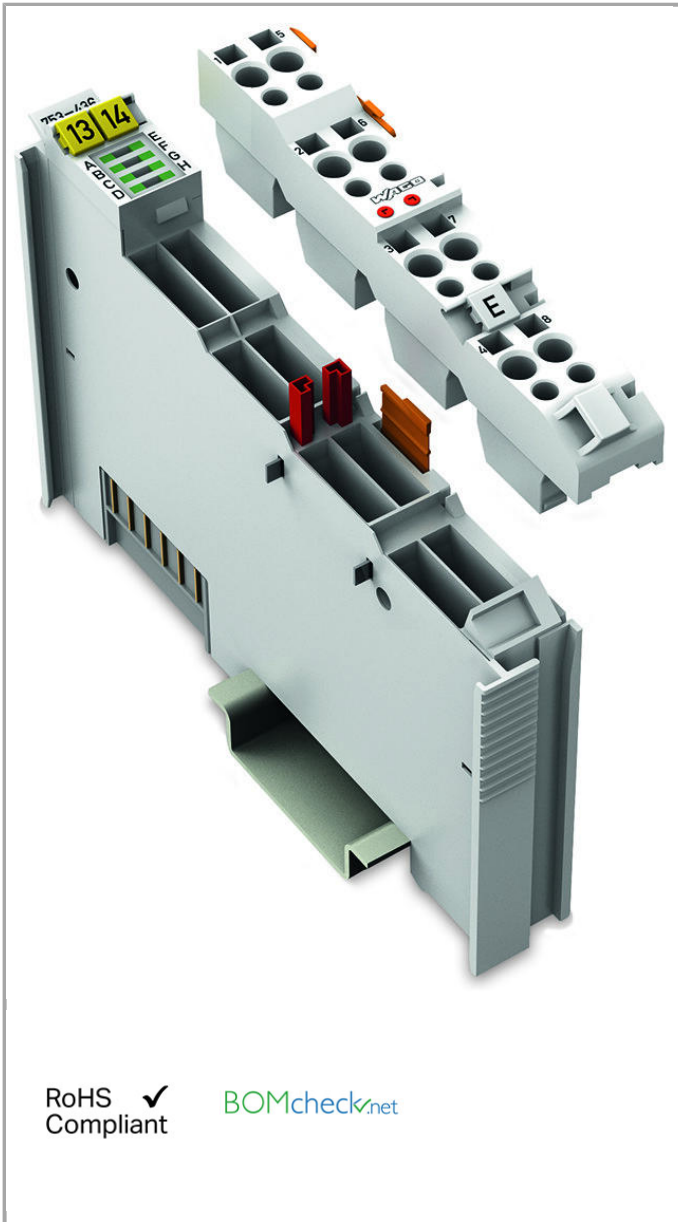
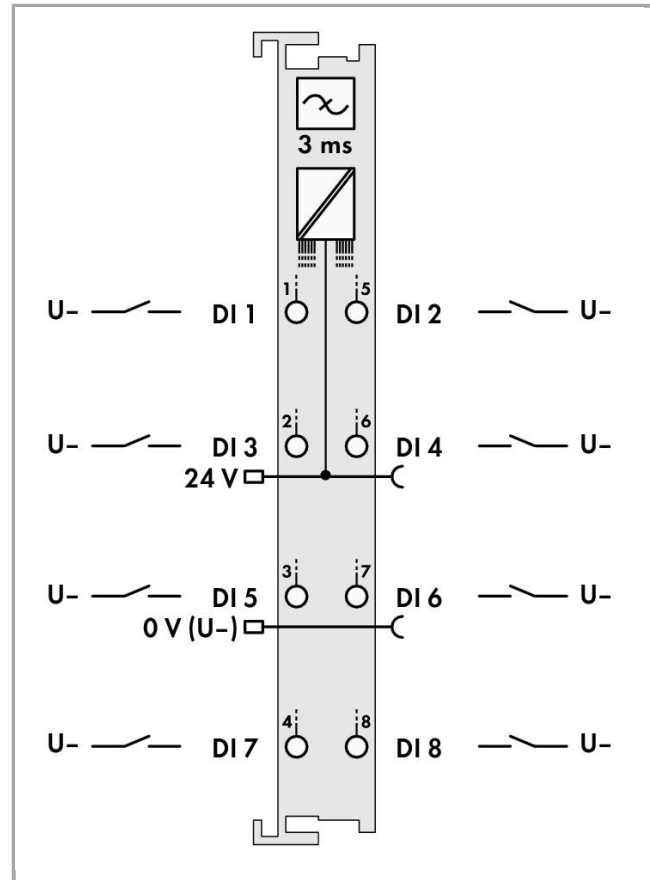
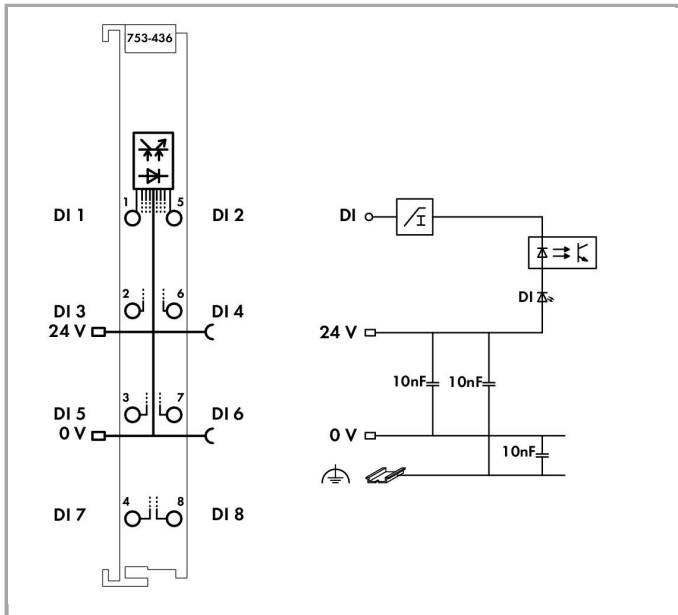

Item description

The digital input module provides 8 channels in a width of just 12 mm (0.47 inch). It receives control signals from digital field devices (e.g., sensors).

Each input module has a noise-rejection filter.

Field and system levels are electrically isolated.

Note:

WAGO's 753 Series Pluggable Connectors and Coding Fingers are not included.

Data

Technical Data

Number of digital inputs	8
Total number of channels (module)	8
Type of signal	Voltage
Sensor connection	8 x (1-conductor)
Input characteristic	low-side switching
Input filter (digital)	3 ms

Input current per channel for signal (0) typ.	2.8 mA
Voltage range for signal (0)	15 ... 30 VDC
Voltage range for signal (1)	-3 ... +5 VDC
Max input data width (internal)	8 Bit
System supply voltage	DC 5 V; via data contacts
Current consumption, system supply (5 V)	13 mA
System and sensor supply voltage)
Field supply voltage	DC 24 V (-25 ... +30 %); über Leistungskontakte (Einspeisung über Messerkontakt; Weiterleitung über Federkontakt)
Isolation field – system	500 VAC (1 min)
Indicators	LED (A-D) green: Status DI 1, DI 3, DI 5, DI 7; LED (E-H) green: Status DI 2, DI 4, DI 6, DI 8
Number of incoming power jumper contacts	2
Number of outgoing power jumper contacts	2
Current carrying capacity of the power jumper contacts	10 A

Connection data

Connection technology: In-/Outputs	8 x CAGE CLAMP®
Connection type (1)	Inputs/Outputs
Solid conductor	0.08 ... 2.5 mm ² / 28 ... 14 AWG
Fine-stranded conductor	0.08 ... 2.5 mm ² / 28 ... 14 AWG
Strip length	9 ... 10 mm / 0.35 ... 0.39 inch

Geometrical Data

Width	12 mm / 0.472 inch
Height	69 mm / 2.717 inch
Height from upper-edge of DIN-35 rail	61.8 mm / 2.433 inch
Depth	100 mm / 3.937 inch

Mechanical data

Type of mounting	DIN-35 rail
Pluggable connector	yes

Material Data

Housing material	Polycarbonate, polyamide 6.6
Fire load	0.977 MJ
Weight	39.663 g
Conformity marking	1

Environmental Requirements



Surrounding air (operating) temperature	0 ... 55 °C
Surrounding air (storage) temperature	-40 ... 85 °C
Protection class	IP20
Degree of pollution (5)	2 per IEC 61131-2
Operating altitude	0 ... 2000 m
Mounting position	horizontal (standing/lying) or vertical
Relative air humidity (no condensation)	95 %
Vibration resistance	4g per IEC 60068-2-6
Shock resistance	15g per IEC 60068-2-27
EMC immunity to interference	acc. to EN 61000-6-2, marine applications
EMC emission of interference	acc. to EN 61000-6-3, marine applications
Exposure to pollutants	Per IEC 60068-2-42 and IEC 60068-2-43
Permissible H ₂ S contaminant concentration at a relative humidity 75 %	10 ppm
Permissible SO ₂ contaminant concentration at a relative humidity 75 %	25 ppm

Commercial data

Product Group	15 (Remote I/O)
Country of origin	DE
GTIN	4045454785918
Customs Tariff No.	85389099990

Approvals / Certificates

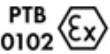





Ex-Approvals

Logo	Approval	Additional Approval Text	Certificate name
	ATEX TUEV Nord Cert GmbH	EN 60079-0	TÜV 07 ATEX 554086 X en.
	TUEV Nord TUEV Nord Cert GmbH	IEC 60079-0	IECEX TUN 09.0001 X
	UL Underwriters Laboratories Inc. (HAZARDOUS LOCATIONS)	ANSI/ISA 12.12.01	E198726 Sec.1

Country specific Approvals

Logo	Approval	Additional Approval Text	Certificate name
	KC National Radio Research Agency	Article 58-2, Clause 3	MSIP- REM-W43- DIM750

Ship Approvals

Logo	Approval	Additional Approval Text	Certificate name
	ABS American Bureau of Shipping	-	19- HG1821926
	BV Bureau Veritas S.A.	-	13453/DO BV
	DNV GL Det Norske Veritas, Germanischer Lloyd	-	TAA0000194
	KR Korean Register of Shipping	-	HMB05880- AC001
	LR Lloyds Register	-	02/20026 (E5)
	PRS Polski Rejestr Statków	-	TE/2236 /880590/19
	RINA RINA Germany GmbH	-	ELE134212XG

UL-Approvals

Logo	Approval	Additional Approval Text	Certificate name
	UL UL International Netherlands B.V. (ORDINARY LOCATIONS)	UL 508	E175199 Sec.1























Compatible products

Supply module

	Item no.: 750-601 Power Supply; 24 VDC	750-601
	Item no.: 750-602 Power Supply; 24 VDC	750-602
	Item no.: 750-610 Power Supply; 24 VDC; fuse holder; Diagnostics	750-610
	Item no.: 750-612 Power Supply; 0 ... 230 V AC/DC	750-612
	Item no.: 753-602 Power Supply; 24 VDC	753-602
	Item no.: 753-612 Power Supply; 0 ... 230 V AC/DC	753-612

















Marking accessories















	Item no.: 2009-145 Mini-WSB Inline; for Smart Printer; on reel; stretchable 5 - 5.2 mm; plain; snap-on type	2009-145
	Item no.: 2009-145/000-002 Mini-WSB Inline; for Smart Printer; on reel; stretchable 5 - 5.2 mm; plain; snap-on type	2009-145 /000-002
	Item no.: 2009-145/000-005 Mini-WSB Inline; for Smart Printer; on reel; stretchable 5 - 5.2 mm; plain; snap-on type	2009-145 /000-005
	Item no.: 2009-145/000-006 Mini-WSB Inline; for Smart Printer; on reel; stretchable 5 - 5.2 mm; plain; snap-on type	2009-145 /000-006
	Item no.: 2009-145/000-007 Mini-WSB Inline; for Smart Printer; on reel; stretchable 5 - 5.2 mm; plain; snap-on type	2009-145 /000-007

	Item no.: 2009-145/000-012 Mini-WSB Inline; for Smart Printer; on reel; stretchable 5 - 5.2 mm; plain; snap-on type	2009-145 /000-012
	Item no.: 2009-145/000-023 Mini-WSB Inline; for smartPRINTER; on reel; stretchable 5 - 5.2 mm; plain; snap-on type	2009-145 /000-023
	Item no.: 2009-145/000-024 Mini-WSB Inline; for Smart Printer; on reel; stretchable 5 - 5.2 mm; plain; snap-on type	2009-145 /000-024
	Item no.: 248-501 Miniature WSB Quick marking system; plain; Marker width 5 mm; 10 strips with 10 markers per card	248-501
	Item no.: 248-501/000-002 Mini-WSB marking card; as card; not stretchable; plain; snap-on type	248-501 /000-002
	Item no.: 248-501/000-005 Mini-WSB marking card; as card; not stretchable; plain; snap-on type	248-501 /000-005
	Item no.: 248-501/000-006 Mini-WSB marking card; as card; not stretchable; plain; snap-on type	248-501 /000-006
	Item no.: 248-501/000-007 Mini-WSB marking card; as card; not stretchable; plain; snap-on type	248-501 /000-007
	Item no.: 248-501/000-012 Mini-WSB marking card; as card; not stretchable; plain; snap-on type	248-501 /000-012
	Item no.: 248-501/000-017 Mini-WSB marking card; as card; not stretchable; plain; snap-on type	248-501 /000-017
	Item no.: 248-501/000-023 Mini-WSB marking card; as card; not stretchable; plain; snap-on type	248-501 /000-023
	Item no.: 248-501/000-024 Mini-WSB marking card; as card; not stretchable; plain; snap-on type	248-501 /000-024
	Item no.: 709-198 Marking strips	709-198
	Item no.: 750-103 Group marker carrier	750-103
	Item no.: 750-107 Group marker carrier	750-107

shield connection

Item no.: 790-108













	Shield clamping saddle; 11 mm wide; diameter of compatible conductor		790-108
	Item no.: 790-116 Shield clamping saddle; 19 mm wide; diameter of compatible conductor; 7 ... 16 mm		790-116
	Item no.: 790-124 Shield clamping saddle; 27 mm wide; diameter of compatible conductor; 6 ... 24 mm		790-124
	Item no.: 790-140 Shield clamping saddle; diameter of compatible conductor		790-140
	Item no.: 790-208 Shield clamping saddle; 12.4 mm wide; 3 ... 8 mm		790-208
	Item no.: 790-216 Shield clamping saddle; 21.8 mm wide; 6 ... 16 mm		790-216
	Item no.: 790-220 Shield clamping saddle; 30 mm wide; 6 ... 20 mm		790-220
system box			
	Item no.: 850-804 IP65 enclosure; Stainless steel; WxHxD (400x123x200 mm); 4 x M20, 16 x M16, 28 x M12 cable grip		850-804
	Item no.: 850-804/000-001 IP65 enclosure; Stainless steel; WxHxD (400x123x200 mm); 2 x M20, 13 x M16, 32 x M12 cable grip	/000-001	850-804
	Item no.: 850-805 IP65 enclosure; Stainless steel; WxHxD (600x123x200 mm); 4 x M20, 19 x M16, 67 x M12 cable grip		850-805
	Item no.: 850-814/002-000 IP65 enclosure; Sheet steel (RAL 7035); WxHxD (200x120x200 mm); without flange plate	/002-000	850-814
	Item no.: 850-815/002-000 IP65 enclosure; Sheet steel (RAL 7035); WxHxD (300x120x200 mm); without flange plate	/002-000	850-815
	Item no.: 850-816/002-000 IP65 enclosure; Sheet steel (RAL 7035); WxHxD (400x120x200 mm); without flange plate	/002-000	850-816
	Item no.: 850-817/002-000 IP65 enclosure; Sheet steel (RAL 7035); WxHxD (600x120x200 mm); without flange plate	/002-000	850-817
	Item no.: 850-825 IP65 enclosure; Aluminium (RAL 7032); WxHxD (160x100x160 mm); 9 x M12, 4 x M20		850-825
	Item no.: 850-826 IP65 enclosure; Aluminium (RAL 7032); WxHxD (240x100x160 mm); 4 x M20, 4 x M16, 14 x M12 cable grip		850-826
	Item no.: 850-826/002-000 IP65 enclosure; Aluminium (RAL 7035); WxHxD (240x100x160 mm); 4 x M20, 4 x M16, 14 x M12 cable grip	/002-000	850-826
	Item no.: 850-827		

	IP65 enclosure; Aluminium (RAL 7032); WxHxD (320x100x160 mm); 4 x M20, 8 x M16, 17 x M12 cable grip		850-827
	Item no.: 850-827/002-000 IP65 enclosure; Aluminium (RAL 7035); WxHxD (320x100x160 mm); 4 x M20, 8 x M16, 17 x M12 cable grip	/002-000	850-827
	Item no.: 850-828 IP65 enclosure; Aluminium (RAL 7032); WxHxD (480x100x160 mm); 4 x M20, 10 x M16, 35 x M12 cable grip		850-828
	Item no.: 850-828/002-000 IP65 enclosure; Aluminium (RAL 7035); WxHxD (480x100x160 mm); 4 x M20, 10 x M16, 35 x M12 cable grip	/002-000	850-828
	Item no.: 850-834 IP65 enclosure; Polyester (RAL 7032); WxHxD (164x100x164 mm); 9 x M12, 4 x M20		850-834
	Item no.: 850-835 IP65 enclosure; Polyester (RAL 7032); WxHxD (244x100x164 mm); 4 x M20, 4 x M16, 14 x M12 cable grip		850-835
	Item no.: 850-836 IP65 enclosure; Polyester (RAL 7032); WxHxD (324x100x164 mm); 4 x M20, 8 x M16, 17 x M12 cable grip		850-836
wiring and connectors			
	Item no.: 706-7753/300-100 System cable; for WAGO-I/O-SYSTEM, 753 Series; 8 digital inputs or outputs; Length: 1 m (1 MOhm); Conductor cross-section: 0.14 mm ²	/300-100	706-7753
	Item no.: 706-7753/301-200 System cable; for WAGO-I/O-SYSTEM, 753 Series; 16 digital inputs or outputs; Length: 2 m; Conductor cross-section: 0.14 mm ²	/301-200	706-7753
transfer module			
	Item no.: 289-611 Interface module; for flat cable connectors per DIN 41651; 10-pole		289-611
	Item no.: 289-614 Interface Module; for flat cable connectors per DIN 41651; 20-pole		289-614
	Item no.: 704-2003 Interface module for system wiring; Pluggable connector per DIN 41651; Male connector; 10-pole; 8-channel digital input or output; 3-wire connection; Triple-deck PCB terminal blocks; in mounting carrier		704-2003
	Item no.: 704-2004 Interface module for system wiring; Pluggable connector per DIN 41651; Male connector; 20-pole; 16-channel digital input or output; 1-wire connection; Double-deck PCB terminal blocks; in mounting carrier		704-2004
	Item no.: 704-2024 Interface module for system wiring; Pluggable connector per DIN 41651; Male connector; 20-pole; 16-channel digital input or output; 2-wire connection; Double-deck PCB terminal blocks; in mounting carrier		704-2024
	Item no.: 704-2044 Interface module for system wiring; Pluggable connector per DIN 41651; Male connector; 20-pole; 16-channel digital input or output; 2-wire connection; PCB disconnect terminal blocks; in mounting carrier		704-2044
	Item no.: 704-2054 Interface module for system wiring; Pluggable connector per DIN 41651; Male connector; 20-pole; 16-		704-2054



channel digital input or output; 3-wire connection; Triple-deck PCB terminal blocks; in mounting carrier

Carrier rail

	Item no.: 210-112 Steel carrier rail; 35 x 7.5 mm; 1 mm thick; 2 m long; slotted; according to EN 60715; "Hole width 25 mm"	210-112
	Item no.: 210-113 Steel carrier rail; 35 x 7.5 mm; 1 mm thick; 2 m long; unslotted; according to EN 60715	210-113
	Item no.: 210-114 Steel carrier rail; 35 x 15 mm; 1.5 mm thick; 2 m long; unslotted; similar to EN 60715	210-114
	Item no.: 210-115 Steel carrier rail; 35 x 7.5 mm; 1 mm thick; 2 m long; slotted; according to EN 60715; "Hole width 18 mm"	210-115
	Item no.: 210-118 Steel carrier rail; 35 x 15 mm; 2.3 mm thick; 2 m long; unslotted; according to EN 60715	210-118
	Item no.: 210-196 Aluminum carrier rail; 35 x 8.2 mm; 1.6 mm thick; 2 m long; unslotted; similar to EN 60715	210-196
	Item no.: 210-197 Steel carrier rail; 35 x 15 mm; 1.5 mm thick; 2 m long; slotted; similar to EN 60715	210-197
	Item no.: 210-198 Copper carrier rail; 35 x 15 mm; 2.3 mm thick; 2 m long; unslotted; according to EN 60715	210-198
	Item no.: 210-504 Steel carrier rail; 35 x 7.5 mm; 1 mm thick; 2 m long; slotted; galvanized; according to EN 60715	210-504
	Item no.: 210-505 Steel carrier rail; 35 x 7.5 mm; 1 mm thick; 2 m long; unslotted; galvanized; according to EN 60715	210-505
	Item no.: 210-506 Steel carrier rail; 35 x 15 mm; 1.5 mm thick; 2 m long; unslotted; galvanized; similar to EN 60715	210-506
	Item no.: 210-508 Steel carrier rail; 35 x 15 mm; 1.5 mm thick; 2 m long; slotted; galvanized; similar to EN 60715	210-508

pluggable wiring tier

	Item no.: 753-110 Plug	753-110
	Item no.: 753-150 753 Series coding elements	753-150

Downloads

Documentation

Bid Text

753-436 IO, 753	Oct 6, 2014	doc 26.1 kB	Download
--------------------	-------------	----------------	----------

Additional Information



Disposal; Electrical and electronic equipment, Packaging

V 1.0.0

pdf
265.8 kB

Download

System Description

Overview on WAGO-I/O-SYSTEM 750 approvals

pdf
780.2 kB

Download

750/753 Series I/O-System – General Product Information

pdf
1.7 MB

Download

CAD/CAE - Smart Data

CAD data

3D Download 753-436

URL

Download

Product family

750/753 Series I/O-System

Learn more about the product family.

Show all products from the family

Subject to changes.
